

XTREME[®] Tachometer

Installation and Operation Instructions

SIEMENS VDO

A u t o m o t i v e

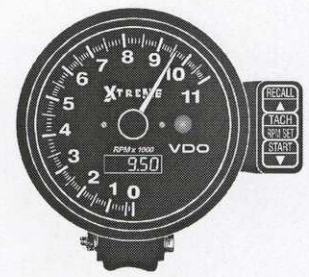

THE INSTRUCTIONS FOR INSTALLATION AND ELECTRICAL WIRING FOR THESE TACHOMETERS FOLLOW. USE IS RESTRICTED TO 12 VOLT NEGATIVE GROUND ELECTRICAL SYSTEMS.

Parts List

Item	Description	Quantity
1.	Tachometer	1
2.	Decals, 2" x 4" (not contingency decals)	2
3.	Posi-Lock [™] Connectors	6

Tachometer Installation

Installing the tachometer is a three-step process.

1. Program the Tachometer

Your Xtreme tachometer is factory programmed for an eight cylinder engine. For other applications the selector switches must be set according to **Diagram A**.

- Remove the 4 cap nuts, lockwashers and rear cover.
- Find your application in **Diagram A** and set the switches accordingly.
- Replace the rear cover, lockwashers and cap nuts. **DO NOT OVERTIGHTEN!**

Optional Items Which May Be Needed:

- Remote Keypad Cable, 6' #240 207
- Flush Dash Mounting Bracket #240 104
- On-Dash Mounting Bracket #240 103

CAUTION: Read these instructions thoroughly before making installation. Always wear safety glasses, and always disconnect the battery ground before making any electrical connections. If in doubt, please contact your dealer or VDO Instruments at **1-800-265-1818**

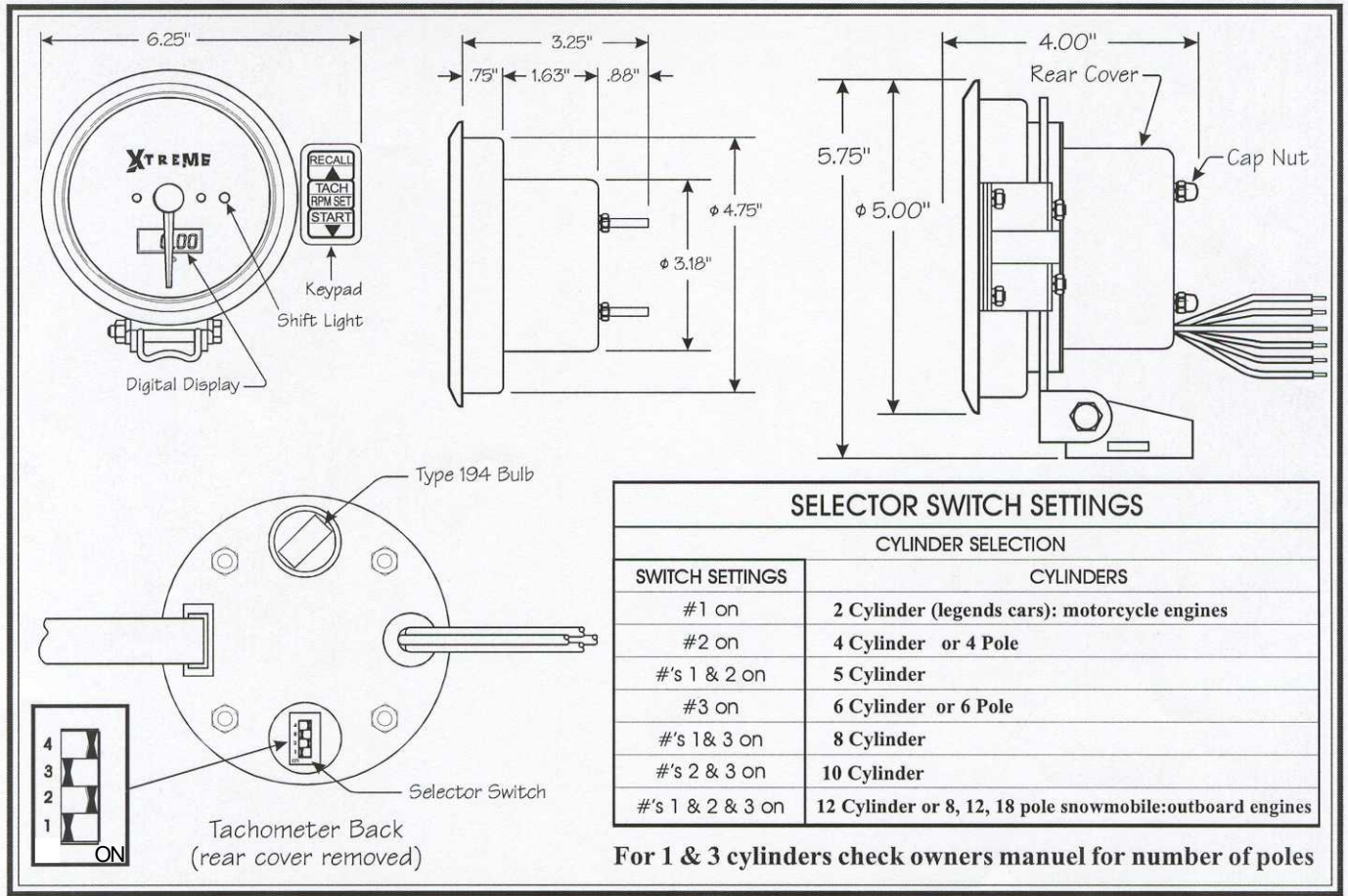

Diagram A

Dimensions and Selector Switch Settings

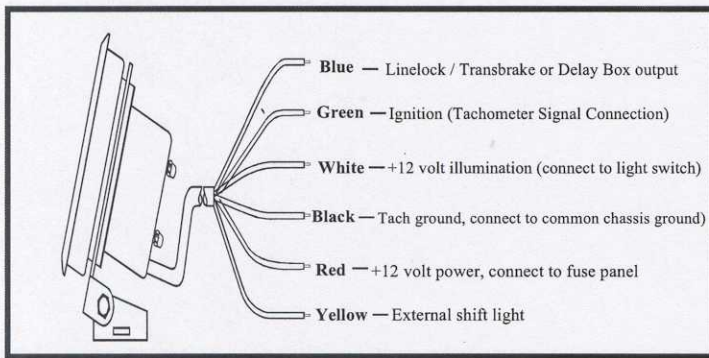

Diagram C
General Wiring Information

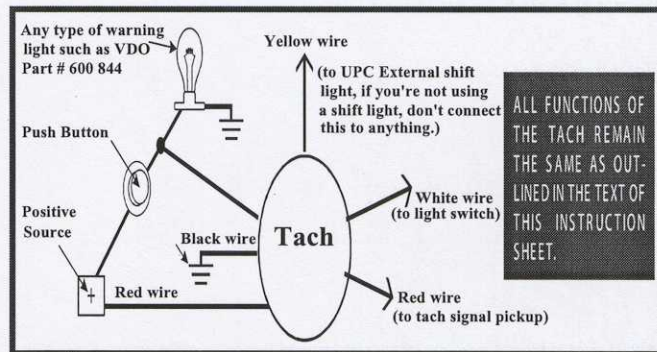

Diagram D
Xtreme Wiring for Circle Track/Road Racing Applications

Xtreme Tachometer Operation

1. Setting the Record Length

- Press and hold in “TACH/RPM SET” while you turn on the power.
- Press the up (▲) arrow to change the record time to 360 seconds, or the down (▼) arrow to change back to 90 seconds [factory setting is for 90 sec.]. A dot appears in the Digital Display when you record and play back in the 360 second mode. Press “TACH/RPM SET” to return to the tach mode.



2. Setting the Shift Points

- Press the “TACH/RPM SET” button while in normal [tach] mode. The tach pointer will move to 3000 RPM [approx.] and a dot will appear in the display to indicate “RPM SET” mode. “S-1” appears in the display itself to indicate you are about to set shift point #1.

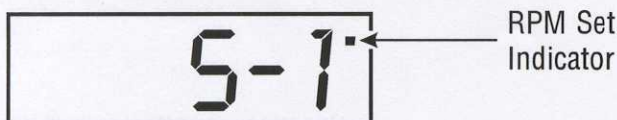

- Press the up (▲) arrow or the down (▼) arrow until the display reads your desired RPM value.
- Press “TACH/RPM SET” again to save this value. The display will show “S-2” briefly, then it will show the second shift RPM value.



- Press “TACH/RPM SET” again to save this value. The display will now show “S-3” briefly, then it will show the third shift RPM value.

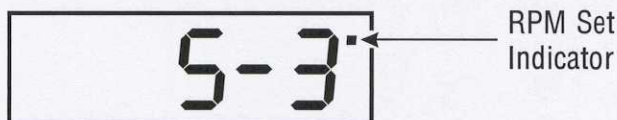

Repeat the above procedure to set your desired third shift RPM value.

- Press “TACH/RPM SET” again to save this value. The display will now show “S-4” briefly, then it will show the fourth shift RPM value.



Repeat the above procedure to set your desired fourth shift RPM value.

- Press “TACH/RPM SET” again to save this value and return to the normal [tachometer] mode.

NOTE: If only one shift point is required, set the second, third and fourth shift point values to the same value as the first shift point value. If two shift points are required, set the third and fourth values the same as the second. If three shift points are required, set the fourth shift point the same as the third.

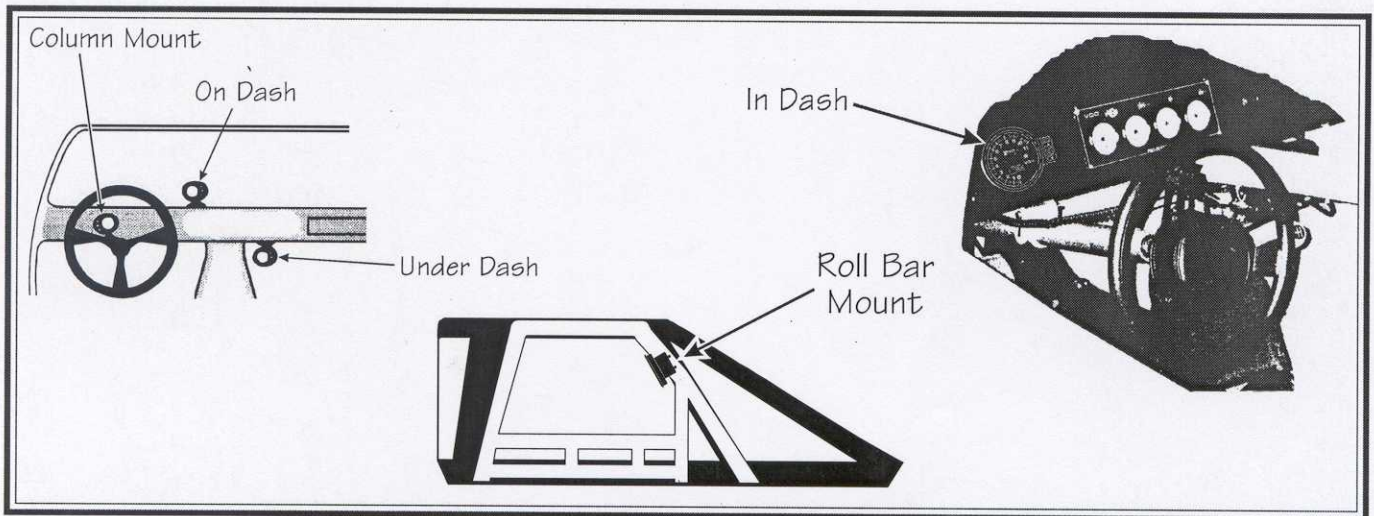

Diagram B

Possible mounting locations for the Xtreme Tachometer

2. Mounting the Tachometer

Your Xtreme tachometer can be mounted almost anywhere. Several suggestions are illustrated in **Diagram B**. Some installation techniques may require optional accessories, cutting, or drilling new holes.

MOUNTING NOTES:

- The most common mounting location is on the steering column or roll cage using a band clamp and the included short mounting bracket.
- For mounting in the dash, optional flush mounting bracket [P/N 240 104] is recommended. The rear cover may also be used as a mounting clamp for in dash mounting.
- For mounting on top of the dash, optional longer mounting bracket [P/N 240 103] is recommended.

REMOTE KEYPAD MOUNTING:

- Remove the four cap nuts, lockwashers and rear cover.
- Pull the keypad cable connector straight out from the back of the tachometer.
- Remove the two hex bolts, keypad and bracket from the tachometer.
- Mount the keypad bracket in the new location.
- Connect optional extension cable [P/N 240 207] between the keypad cable connector and the connector at the rear of the tachometer.
- Replace the rear cover, lockwashers and cap nuts. **DO NOT OVERTIGHTEN!**

MOUNTING CAUTIONS:

- Make sure your Xtreme Tachometer does not rest against any glass, windshield A pillars, or any roll cage tubes.
- VDO does not recommend mounting your Xtreme

Tachometer close to other electrical components or their associated wiring. For example, the ignition system box, the ignition coil, electric fuel pump, etc.

3. Wiring the Tachometer

- Turn off the ignition and disconnect the negative terminal from the battery post if you haven't already done so.
- Wire the tachometer to the vehicle as shown in either **Diagram C** * or **Diagram D** *.

* Refer to your vehicle's owner/service manual or the aftermarket ignition manufacturer's instructions for the recommended place to tap the signal. Typical examples are shown in the table below.

IGNITION	TYPE	CONNECTIONS
Standard	points/breakerless	negative terminal on coil
CD	points	points connection to CD box
	breakerless	positive terminal on coil
Electronic	MSD, ACCEL, MALLORY, DDIS (distributorless), etc.	Tach output terminal on ignition box, or points connection to ignition box, or negative coil

- Be sure to connect the tachometer wires using the supplied Posi-Lock™ Connectors. Use them as shown in the following illustration:

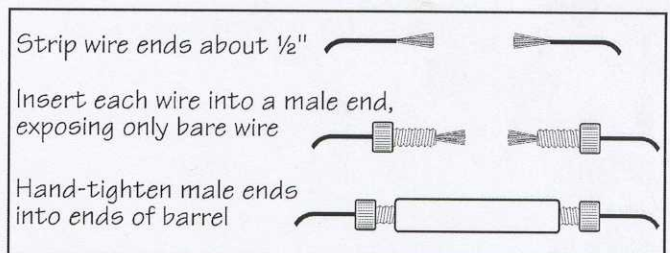

3. To Record A Run

- Press the “START” button [or activate “LINE LOCK / TRANSBRAKE” if connected]. Once recording has begun, the display will show the number of the run being stored (#1 to #4).
- If four runs are stored and the “START” button is pushed [or “LINE LOCK / TRANSBRAKE” is activated], the display will read



↓

If a driver has already started a run when he presses “START” and discovers the memory full, he has five seconds to press “START” again to clear the memory and record his current run. If the driver chooses not to clear memory at this time, the Xtreme Tachometer will return to normal mode in 5 seconds. He can wait until the end of his run to clear the memory as outlined in Step 5.

- To stop recording, either press “TACH/RPM SET” or turn off the power. In any case, recording will stop automatically after the elapse of the preset time: 90 or 360 seconds.

4. To Recall A Run

- Press the “RECALL” button. The display will show the default 1:3 [slow motion] setting. If you want to play back the run in real time (1:1), quickly [within two seconds] press “RECALL” again.



- The display will now show the number of the last run recorded (1, 2, 3 or 4). If the number of the run showing on the display is not the run you want to play back, quickly [within two seconds] press “RECALL” again (and again and again, etc.) to cycle through the run numbers until you get to the one you want to play back. Playback begins after 2 seconds.
- To rewind or fast forward at any time during playback, press (▼) [rewind] or (▲) [fast forward]. Fast forward will occur at double time if real-time [1:1] playback is selected. Fast forward will occur in real time if slow motion playback is selected.
- If the recording was activated using LINE LOCK or TRANS BRAKE, the display will count down to the point of last release to show launch. If FAST FORWARD or REWIND is pressed, the display will pause at the point of each line lock release. When the replay is finished, the display will read “END” and show the peak RPM achieved.

NOTE: RECALL will not function if the input is above 2000 RPM.

5. To Clear the Memory

- Press (▲) and (▼) at the same time and hold in the buttons while turning on the power.

The display will flash twice:



When it is finished flashing the memory will be clear and ready for a new test session.

HELPFUL HINTS TO AVOID ERRATIC TACH READINGS DURING REPLAY:

- Check plug wires. If they're more than a season old, replace them.
- Are the crank trigger wires too close to the coil wire?
- Coil wires begin fatiguing faster than other wires...some at 60 passes or ½ season. Check them.
- Is the spark plug gap more than .040? Gaps of more than .040 will cause the wires to fatigue faster.

VDO Limited Warranty

VDO North America, LLC. warrants all merchandise against defects in factory workmanship and materials for a period of 24 months after purchase. This warranty applies to the first retail purchaser and covers only those products exposed to normal use or service. Provisions of this warranty shall not apply to a VDO product used for a purpose for which it is not designed, or which has been altered in any way that would be detrimental to the performance or life of the product, or misapplication, misuse, negligence or accident. On any part or product found to be defective after examination by VDO North America, VDO North America will only

repair or replace the merchandise through the original selling dealer or on a direct basis. VDO North America assumes no responsibility for diagnosis, removal and/or installation labor, loss of vehicle use, loss of time, inconvenience or any other consequential expenses. The warranties herein are in lieu of any other expressed or implied warranties, including any implied warranty of merchantability or fitness, and any other obligation on the part of VDO North America, or selling dealer. (NOTE: This is a “Limited Warranty” as defined by the Magnuson-Moss Warranty Act of 1975.)